



ANGLED LIGHT BARRIERS

WITH IO-LINK

 **di-soric**

ANGLED LIGHT BARRIERS WITH IO-LINK: OGL . OGLP . OGLL LASER

**MORE FLEXIBLE, FASTER, MORE PRECISE, SIMPLER AND
EVEN MORE RUGGED - WITH THE EXACT SAME SIZE.**

For decades, di-soric has been developing angled light barriers that set new standards. We are now offering the angled light barrier 4.0 with an innovative dual operation concept, either over IO-Link with the configuration of all sensor functions including 4 selectable sensor modes or through easy manual switching point adjustment with a potentiometer.

Ready-to-run: 4 preconfigured sensor modes

- Standard
- High Resolution
- Power
- Speed

Operating distances (optical axis) of 60 - 158 mm

for a wide variety of applications

Backward compatible

with previous di-soric OGL models
in terms of design and M8 connection

Very easy operation

Adjustment of the switching
point and NO/NC changeover
using a potentiometer

Push-pull output

pnp or npn function
in one device

Even more rugged design

in a powder-coated metal housing with full
encapsulation and IP67, compatible with all
OGL and standard mounting options

IO-Link

Selection of the sensor mode
over IO-Link or teach-in



THE EVOLUTION OF THE STANDARD: OGL – ANGLED LIGHT BARRIERS 4.0

APPLICATION-SPECIFIC CONFIGURATION INSTEAD OF SPECIFIC HARDWARE.

Instead of keeping various angled light barriers on hand for different applications, you can save the application-specific configuration, load it into the angled light barrier as needed or select the necessary operation mode and get started right away. Device swapping works just as easily.

Benefits of the angled light barriers OGL with IO-Link:

- High resolution and reproducibility at outstanding speed
- 4 pre-configured sensor modes:
Standard mode is the default. The High Resolution, Speed and Power modes can be selected via IO link
- Preferred field of application:
Detection of parts in assembly, handling and packaging technology

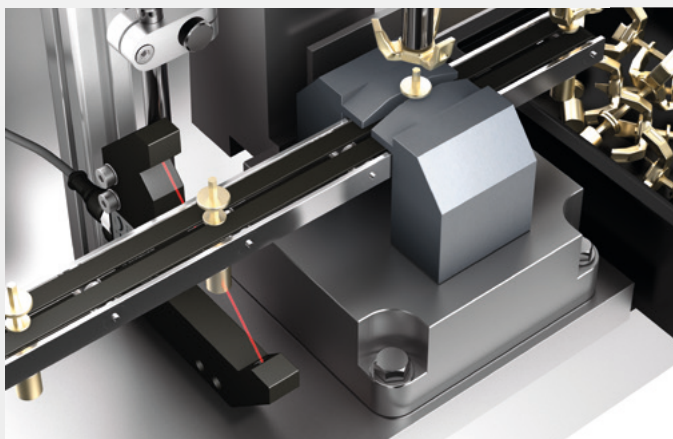

Presence check

OGL 051 G3-T3

Contour monitoring of bolts – with low space requirements: They have the advantage of configuration via IO-Link, since the potentiometers are not directly accessible.

Due to the high resolution and reproducibility of the OGL even at high speeds, higher than average throughput rates can be achieved.

The robustness of the OGL and diagnosis via IO link result in reduced maintenance intervals and maintenance time.

OGLP – OUR STRONG ONES. FOR WHEN THINGS GET DIRTY.

LONG AFTER OTHER SENSORS HAVE GIVEN UP, THE OGLPS STILL HAVE PLENTY OF RESERVES LEFT.

Available with branch lengths of 60, 100, 158 mm, the OGLP-series ensures precise object detection regardless of the surface, even in dirty and oily production environments. With reproducibility of 0.03 mm, the angled light barriers offer a high degree of precision paired with maximum function reserve.

Additional benefits of the rugged OGLP infrared high-performance angled light barriers:

- Maximum function reserve while maintaining high switching accuracy
- Power sensor mode set by default; the Standard, High Resolution and Speed sensor modes can be freely selected
- Preferred field of application: mechanical engineering applications involving large amounts of dust, coolant or oil

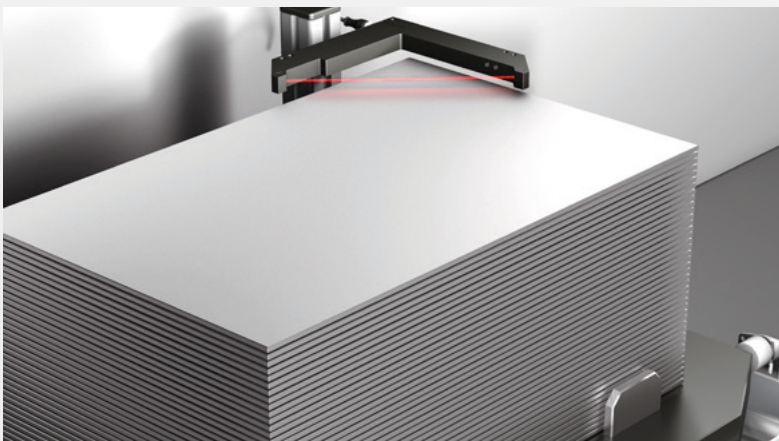

Stack height check

OGLP 121 G3-T3

A robot in a robot cell always picks up the top sheet from a magazine for further processing.

Thanks to the angled light barrier OGLP with high functional reserve, sheets can be repositioned with a reproducibility of 0.03 mm, even in dirty environments.

OGLL LASERS - MAXIMUM PRECISION. ACCURATE DOWN TO HUNDREDTHS OF A MM.

THE OGLLS DETECT RAPID-CYCLE OBJECTS WITH PROCESS RELIABILITY, DOWN TO A SIZE OF 0.03 MM.

The OGLL series is the best solution when the goal is process-reliable and fast detection of very small objects down to a size of just 0.03 mm.

With OGLL angled light barriers the position and alignment of thin wires, drill bits or cannulae can effortlessly be defined down to a (reproducible) accuracy of 0.01 mm.

Additional benefits of the precise laser angled light barriers OGLL:

- Fast, reliable detection of the smallest parts with a high functional reserve
- 4 pre-configured sensor modes: Standard mode is the default – the High Resolution, Speed and Power modes can be selected via IO-Link
- Preferred field of application: Detection of very small parts in assembly, handling and packaging technology, as well as quality control
- Robust, powder-coated metallic housing in the high protection class IP67

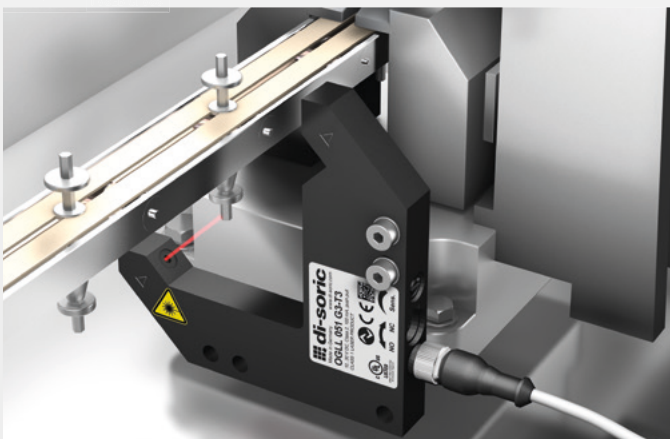

Checking connector contacts

OGLL 051 G3-T3

At a supply unit that feeds an assembly machine, a laser angled light barrier from the OGLL series is used in narrow installation spaces. It checks supplied components to see whether the very thin connector contacts are present.

The high resolution of the laser sensor ensures that even extremely thin wires are reliably detected.



The good visible laser light spot allows the sensor to be aligned and adjusted quickly and precisely.

SMART THANKS TO IO-LINK. SAVE TIME AND MONEY.

GET STRAIGHT TO THE POINT.

IO-Link provides a point-to-point connection within any network, fieldbus or backplane bus. The IO-Link master can be installed either directly in the field or in the control cabinet. The international IO-Link standard (in accordance with IEC 61131-9) is now regarded as an "Enabler for Industry 4.0"

RELIABLE, HIGH-PERFORMANCE APPLICATIONS USING OUR ANGLED LIGHT BARRIERS WITH IO-LINK.

	4 SENSOR MODES	
	Standard	<ul style="list-style-type: none">Switching frequency: 5000 HzReproducibility: 0,02 / 0,01 mm¹
	High Resolution	<ul style="list-style-type: none">Resolution for small parts detection improved by 30%
	Power	<ul style="list-style-type: none">Increased transmitting power and thus increased function reserve with reduced sensitivity to dirt
	Speed	<ul style="list-style-type: none">Fast operation at up to 10000 Hz switching frequency
	DIAGNOSTICS	Qualitative and quantitative diagnostics: <ul style="list-style-type: none">Analysis of process stability and teach-in quality (qualitative)Current process values, min/max, teaching and threshold measured values (quantitative)
	EASY MAINTENANCE	<ul style="list-style-type: none">Device swapping without manual intervention or specialized knowledge thanks to IO-Link 1.1 with data storage in the masterSmart Sensor Profile – fully compliant with standards

¹ Angled light barriers OGL with branch length inside up to 80 mm / OGLL



5 REASONS TO CHOOSE OUR ANGLED LIGHT BARRIERS WITH IO-LINK.

- 1 Cost reduction thanks to reduced stockkeeping**
 - One sensor can provide the solution for various applications by adjusting the configuration. Application-specific sensors are no longer necessary.
- 2 Implementation of innovative machine concepts thanks to consistent communication**
 - Recipe management in the IO-Link master, remote maintenance, diagnostics, sensor-configuration in accordance with the standardized Smart Sensor Profile
- 3 Reduction of commissioning times through standard cabling and data storage in the master**
 - Standard plug connectors and push/pull outputs
 - The sensor can be configured directly over the IO-Link master and is saved in the master with IO-Link 1.1
- 4 Increased machine productivity through configuration and identification**
 - Additional functionality integrated directly into the sensor:
Sensor modes, teach-in, evaluation of signal values, pulse extension, operation lock
- 5 Revolutionizing maintenance through self-diagnostics and data storage**
 - Process stability diagnostics (e.g. function reserve)
 - Easy device swapping without manual intervention or specialized knowledge thanks to data storage in IO-Link 1.1 master

TECHNICAL DATA

OGL WITH IO-LINK



	OGL 05x G3-T3	OGL 08x G3-T3	OGL 12x G3-T3
			
Housing dimensions H/W/D	75 / 75 / 10 mm	105 / 105 / 10 mm	150 / 150 / 12 mm
Branch length inside	50 / 50 mm	80 / 80 mm	120 / 120 mm
Operating distance (optical axis)	60 mm	100 mm	158 mm
Red light, 660 nm	OGL 051 G3-T3	OGL 081 G3-T3	OGL 121 G3-T3
Infrared light, 880 nm	OGL 050 G3-T3	OGL 080 G3-T3	OGL 120 G3-T3
Resolution (Smallest detectable part)	Ø 0.3 mm (min. Ø 0.2 mm) ¹	Ø 0.3 mm (min. Ø 0.2 mm) ¹	Ø 0.5 mm (min. Ø 0.4 mm) ¹
Reproducibility	0.02 mm	0.02 mm	0.03 mm
Switching frequency	5 000 Hz (max. 8 000 Hz) ²	5 000 Hz (max. 8 000 Hz) ²	5 000 Hz (max. 8 000 Hz) ²
Switching output	Push-pull/pnp/npn adjustable via IO-Link, 100 mA, NO/NC (switchable via potentiometer or IO-Link)		
Interface	IO-Link V1.1, COM2 Smart Sensor Profile		
Sensitivity adjustment	Using potentiometer or IO-Link		
Sensor modes	Standard – General applications High Resolution – For detection of the smallest objects Power – Increased function reserve Speed – Safe detection of fast-moving parts		
Special feature			
Protection type / class	IP67 / III		
Connector	M8, 3-pin		
Connection cable	TK...		

Factory setting OGL: Sensor mode **Standard**



¹ in the **High Resolution** sensor mode

² in the **Speed** sensor mode

TECHNICAL DATA

OGLP WITH IO-LINK





	OGLP 050 G3-T3	OGLP 080 G3-T3	OGLP 120 G3-T3
			
Housing dimensions H/W/D	75 / 75 / 10 mm	105 / 105 / 10 mm	150 / 150 / 12 mm
Branch length inside	50 / 50 mm	80 / 80 mm	120 / 120 mm
Operating distance (optical axis)	60 mm	100 mm	158 mm
Emitted light	Infrared light, 860 nm		
Resolution (Smallest detectable part)	Ø 2.0 mm (min. Ø 0.2 mm) ¹	Ø 2.0 mm (min. Ø 0.2 mm) ¹	Ø 2.0 mm (min. Ø 0.4 mm) ¹
Reproducibility	0.03 mm (min. 0.02 mm) ¹	0.03 mm (min. 0.02 mm) ¹	0.03 mm (min. 0.02 mm) ¹
Switching frequency	200 Hz (max. 8000 Hz) ²	200 Hz (max. 8000 Hz) ²	200 Hz (max. 8000 Hz) ²
Switching output	Push-pull/pnp/npn adjustable via IO-Link, 100 mA, NO/NC (switchable via potentiometer or IO-Link)		
Interface	IO-Link V1.1, COM2 Smart Sensor Profile		
Sensitivity adjustment	Using potentiometer or IO-Link		
Sensor modes	Standard – General applications High Resolution – For detection of the smallest objects Power – Increased function reserve Speed – Safe detection of fast-moving parts		
Special feature	Dirt-resistant		
Protection type / class	IP67 / III		
Connector	M8, 3-pin		
Connection cable	TK...		

Factory setting OGLP: Sensor mode **Power**
¹ in the **High Resolution** sensor mode
² in the **Speed** sensor mode

TECHNICAL DATA

OGLL LASER WITH IO-LINK



	OGLL 051 G3-T3	OGLL 081 G3-T3	OGLL 121 G3-T3
			
Housing dimensions H/W/D	75 / 75 / 10 mm	105 / 105 / 10 mm	150 / 150 / 12 mm
Branch length inside	50 / 50 mm	80 / 80 mm	120 / 120 mm
Operating distance (optical axis)	60 mm	100 mm	158 mm
Emitted light	Red light laser, clocked, 655 nm, Laser class 1, IEC60825-1:2014		
Resolution (Smallest detectable part)	Ø 0.05 mm (min. 0.03 mm) ¹	Ø 0.05 mm (min. Ø 0.04mm) ¹	Ø 0.1 mm (min. Ø 0.5 mm) ¹
Reproducibility	0.01 mm	0.01 mm	0.01 mm
Switching frequency	5 000 Hz (max. 10 000 Hz) ²	5 000 Hz (max. 10 000 Hz) ²	5 000 Hz (max. 10 000 Hz) ²
Switching output	Push-pull/pnp/npn adjustable via IO-Link, 100 mA, NO/NC (switchable via potentiometer or IO-Link)		
Interface	IO-Link V1.1, COM2 Smart Sensor Profile		
Sensitivity adjustment	Using potentiometer or IO-Link		
Sensor modes	Standard – General applications High Resolution – For detection of the smallest objects Power – Increased function reserve Speed – Safe detection of fast-moving parts		
Special feature	Mountable side by side		
Protection type / class	IP67 / III		
Connector	M8, 3-pin		
Connection cable	TK...		

Factory setting OGLL: Sensor mode **Standard**

¹ in the **High Resolution** sensor mode

² in the **Speed** sensor mode

ACCESSORIES FOR SENSORS.

CUSTOMIZED ACCESSORIES FOR ANGLED LIGHT BARRIERS.

It is not only the quality of the sensors that plays a major role in the process-reliable detection of parts and objects. The accessories are also very important. They can ensure flexible, stable mounting, secure signal transmission and much more.



Connection technology

In the area of connection technology, a wide variety of electrical contacts for individual industrial-suited mounting are available.

Logic modules / Function adapters / Counter modules

di-soric offers logic modules, function adapters and counter modules for nearly all requirements. Logic modules can logically connect several sensors together and output the desired behavior accordingly, for example an AND/OR function. Function adapters can change sensor-specific functions to the desired function (e.g. pulse stretching). Counter modules count the output signals of the different sensors.



THE COMPLETE SET OF ACCESSORIES CAN BE FOUND AT WWW.DI-SORIC.COM

Our extensive portfolio of accessories ranges from the IOL-Master to the configuration of sensors with IO-Link, to simple brackets and cables with which sensors can be securely fastened and connected at the operation site, to logic modules, function adapters and counter modules, which provide extended functions.



IOL-Master

The universal IO-Link master has an M12 connector and supports the configuration of devices with IODD specification 1.0.1 and 1.1 through the included PC software.

Mounting technology

di-soric offers tailored bracket and fastening systems for all of its sensors, image processing and identification systems, as well as lighting. Our universal fasteners and HS fastening system are designed for secure and adjustable mounting of the various sensors and lighting systems. Various system and sensor brackets make it possible to offer an individual solution that is perfectly adapted to your applications.



SOLUTIONS. CLEVER. PRACTICAL.

di-soric Headquarters

Germany: di-soric GmbH & Co. KG | Steinbeisstrasse 6 | 73660 Urbach
Phone +49 71 81 98 79-0 | Fax +49 71 81 98 79-179 | info@di-soric.com

di-soric Subsidiaries

Austria: di-soric Austria GmbH & Co. KG | Phone +43 7228 72 366 | info.at@di-soric.com

France: di-soric SAS | Phone +33 476 61 65 90 | info@di-soric.fr

Singapore: di-soric Pte. Ltd. | Phone +65 6634 38436 | info.sg@di-soric.com

Switzerland: di-soric SNT AG | Phone +41 44 817 29 22 | info.ch@di-soric.com

The Netherlands: di-soric B. V. | Phone +31 413 33 13 91 | info.nl@di-soric.com

For further information visit www.di-soric.com/international

www.di-soric.com